





Made in Italy



ENGI lighting vent'anni di passione per la luce



1997 Nasce ENGI

ENGI viene fondata nel 1997. Si distingue ben presto tra le aziende del settore nella fornitura di apparecchi di illuminazione esterna ed interna, industriale e civile, diventando distributore esclusivo per l'Italia di prestigiose aziende internazionali.

2000 La produzione a led

Nel 2000 inizia la produzione in Italia con l'utilizzo della nuova tecnologia a led, con apparecchi che si distinguono per funzionalità, eleganza, qualità e tecnologia.

Tutti i prodotti sono Made in Italy e realizzati con un team di designers, progettisti e ricercatori.



2017 Vent'anni di passione per la luce

In occasione del 20° compleanno di ENGI viene ampliata la gamma iniziando una collaborazione con maestri artigiani veneti. Si intraprende così la produzione fatta a mano di apparecchi realizzati con l'utilizzo di materiali come vetro, ceramica, legno e metalli e integrati con la più avanzata tecnologia a led.



2019 ENGI è impegnata nello sviluppo totale del prodotto. Gli apparecchi di illuminazione utilizzano sempre più tecnologie IoT e di interconnessione in rete e possono essere gestiti e abilitati da device portatili per il comando e la regolazione o integrati con sensori per il monitoraggio ambientale.

ENGI lighting 20 years of passion for lighting

1997

ENGI was founded in 1997 and became a leading Company in lighting for interior and exterior, for private and public use. ENGI is currently distributor of several international lighting Companies.

2000

In 2000 ENGI started to manufacture in Italy its luminaires with led technology. Our products are characterized from the beginning for elegance, quality, technology and functionality. All products are Made in Italy and they are realized in collaboration with designer, lighting projects and researchers.

2017 20 years of passion for lighting

Our products' range is enlarged with a collaboration with local artisan. ENGI starts in this way handmade manufacturing with materials as glass, ceramic, wood, metals and combined with led technology.

2019 The Company aims to maintain its position as a prime forerunner of technology within the industry: luminaires are more and more on web and use IoT technologies, controlled by remote devices or integrated with sensors for environmental monitoring.

CERTIFICATO DI AUTENTICITÀ

ENGI srl fornisce ai propri clienti prodotti tecnologicamente avanzati e al contempo unici, molti dei quali vengono garantiti, allegando alla consegna del prodotto un certificato numerato che attesta l'autenticità dell'oggetto.

CERTIFICATE OF AUTHENTICITY

ENGI SRL creates and supplies products that are technologically innovative unique. A certificate of authenticity is provided together with the product.







Nella terra del Palladio e di Canova
giovani maestri artigiani
perpetuano la tradizione millenaria
dell'arte e della creatività realizzando
a mano opere uniche
ricche di fascino e suggestione.



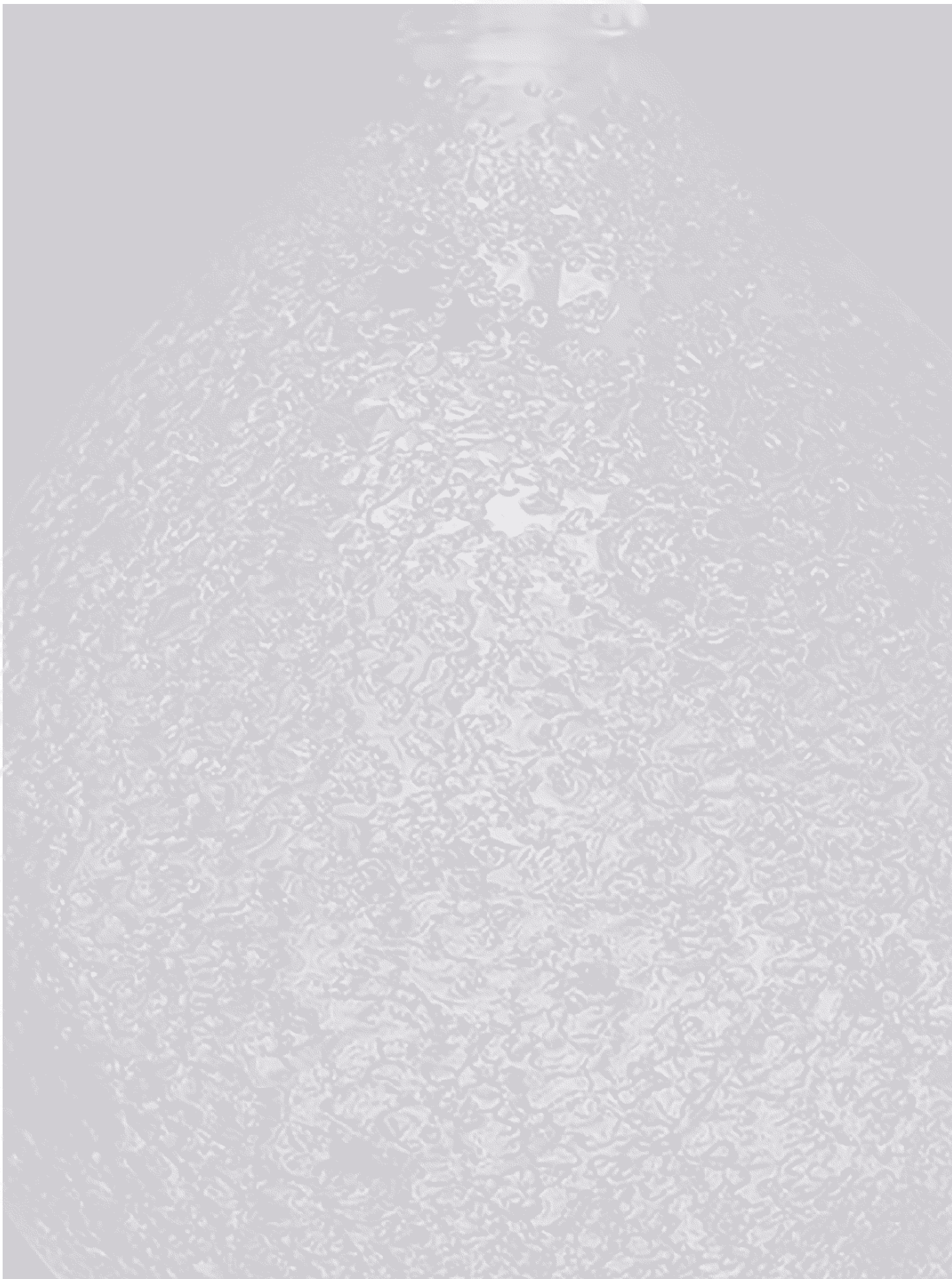



VETRO

GLASS



IL VETRO

Il vetro, perfezione imperfetta di un materiale antichissimo.

Il vetro soffiato è un materiale affascinante per la sua trasparenza, forma, robustezza, riciclabilità e con la sua lavorazione diventa un prodotto unico ed irripetibile.

Con la lavorazione del vetro borosilicato soffiato e lavorato completamente a mano si ottengono creazioni artistiche vive, colorate che si combinano con l'esigenza di una perfetta illuminazione. Inoltre le nostre lampade sono completate da uno strato di vetro fuso su tutta la superficie interna, che elimina gli abbagliamenti e crea atmosfere accoglienti e riposanti.

GLASS

The imperfect perfection of an ancient material. Modern or classic glass is a special material to apply to luminaires and to exite us.

The blown glass is a fascinating material for its clearness, shape and strenght; it is totally recyclable and after manufacturing it becomes a unique piece of art.

With the manufacturing of borosilicate blown glass, entirely handmade, we realize colourful and alive products that responds to the demand of a perfect lighting.

All our products are finished with a blown glass' foil placed in the interior part that reduces glare and gives a warm and relaxing effects.



Lampade in vetro

Glass luminaires

in collaboration with

MAESTRI ARTIGIANI BASSANESI

Made in Italy



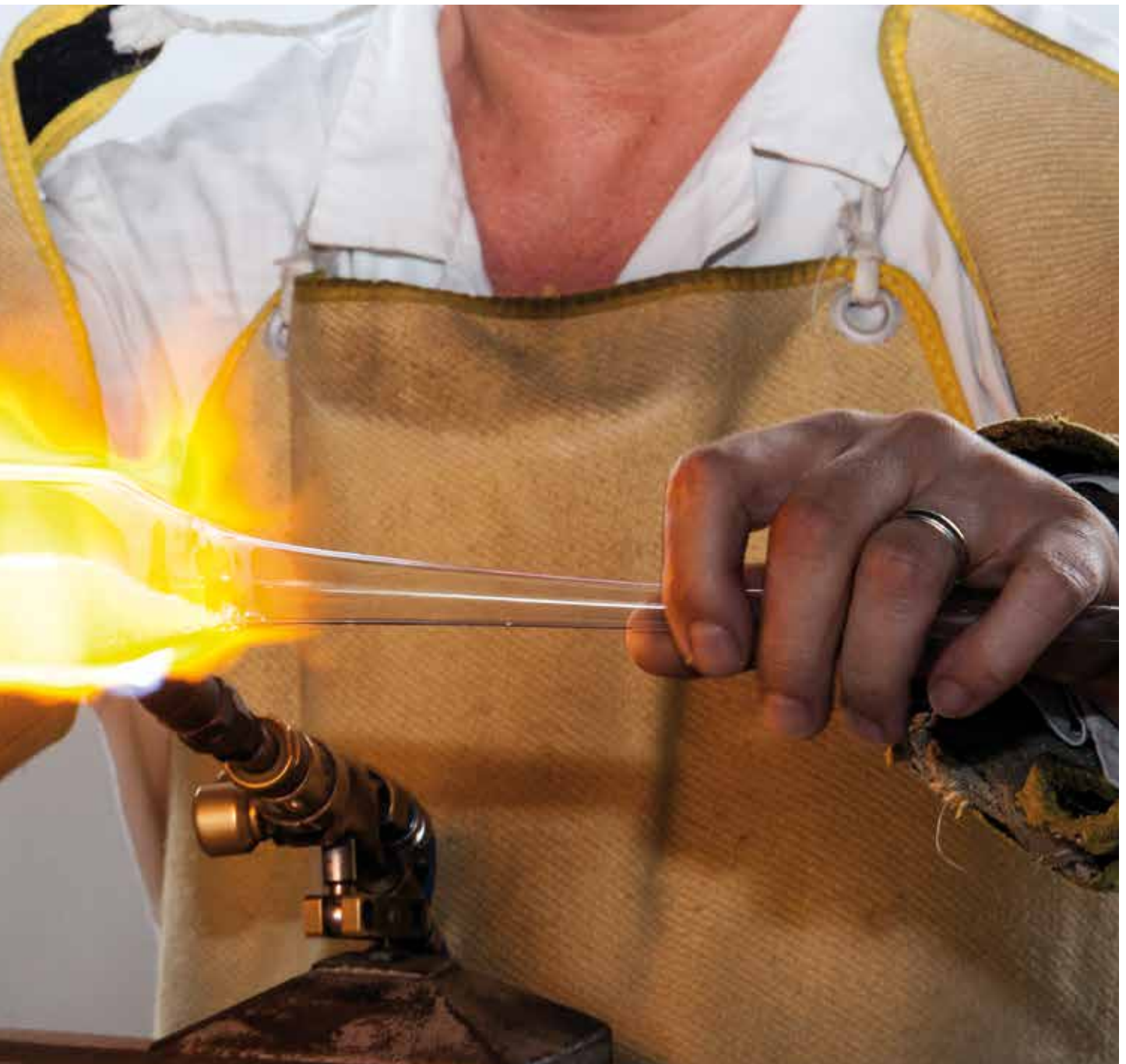

ALLEGRA

Lampada a sospensione in vetro
Pendant LED luminaire in glass



ALLEGRA transparent
ALLEGRA yellow
ALLEGRA blue

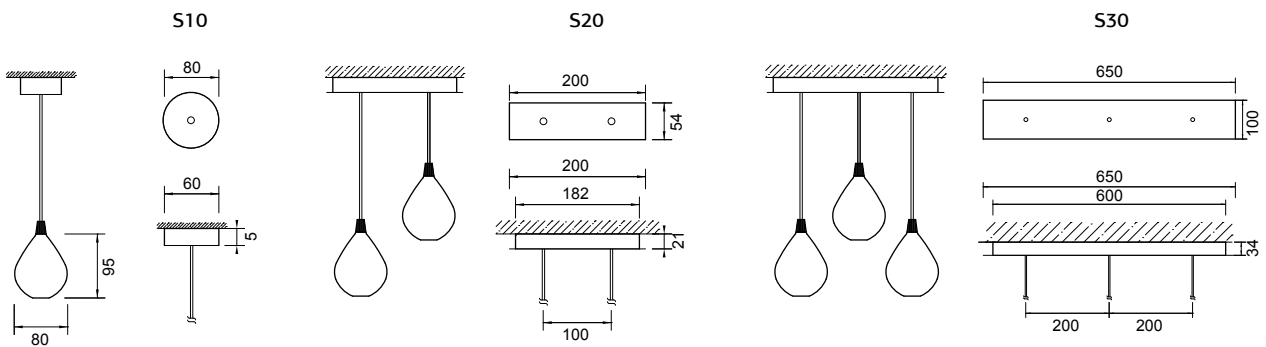

LED 4W - G9 - 230Vac - 2700K **CE**
Peso / Weight 0,15 kg single piece



DIAMANTE

Lampada a sospensione in vetro
Pendant LED luminaire in glass



DIAMANTE transparent
DIAMANTE green
DIAMANTE blue

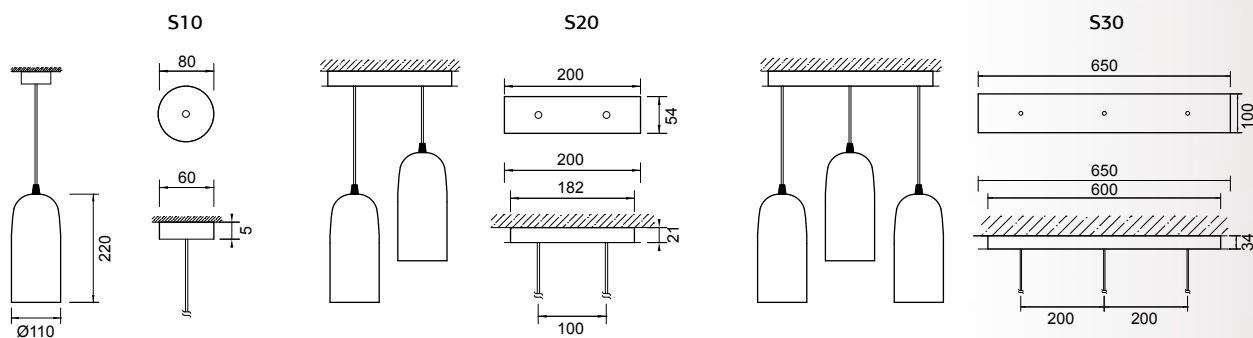

LED E27 - excluded lamp - 230Vac **CE**
 Peso / Weight 0,40 kg single piece



LUCENTE

Lampada a sospensione in vetro
Pendant LED luminaire in glass



LUCENTE transparent

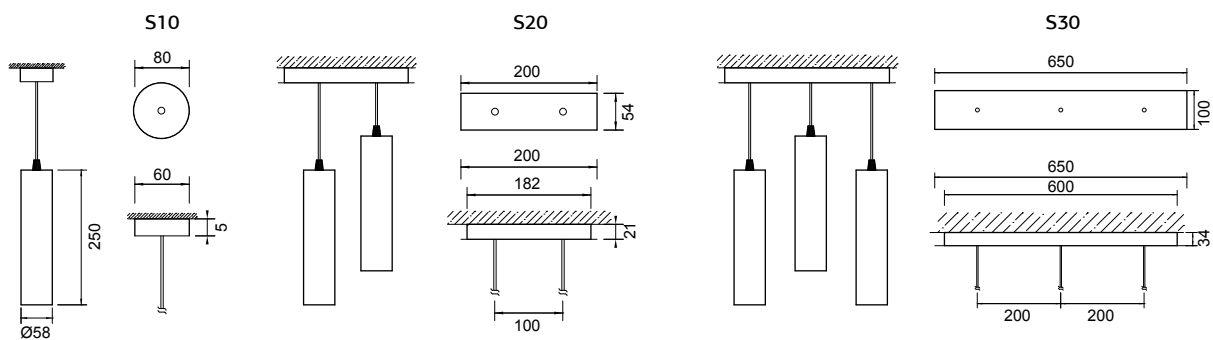

LED E14 – excluded lamp – 230Vac **CE**
Peso / Weight 0,27 kg single piece



BOLLA

Lampada a sospensione in vetro
Pendant LED luminaire in glass



BOLLA transparent

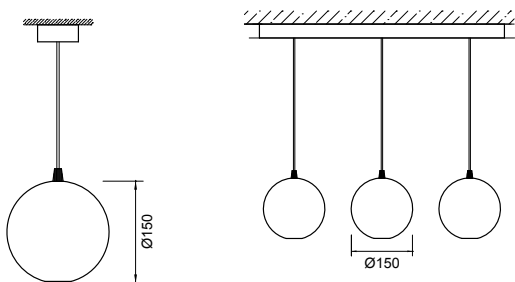

LED E14 – excluded lamp – 230Vac **CE**
Peso / Weight 0,40 kg



DIN-DON

Lampada a sospensione in vetro opale
Pendant LED luminaire in opal glass



DIN-DON opal

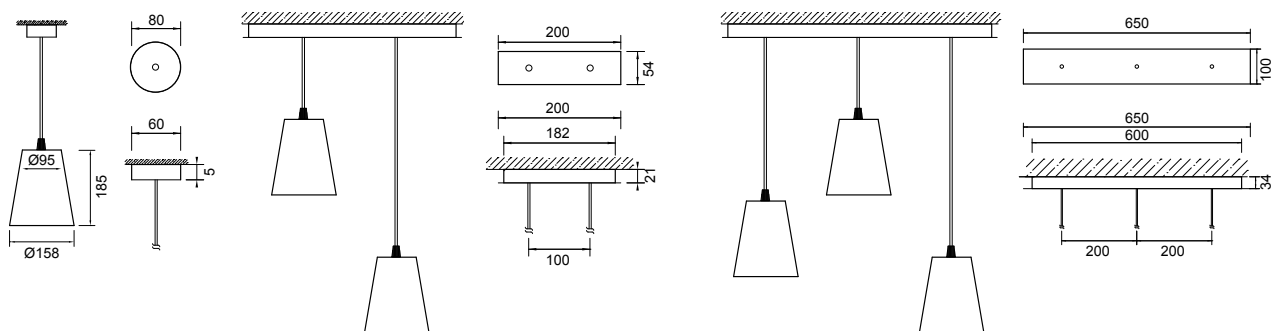

LED E27 – excluded lamp – 230Vac **CE**
Peso / Weight 0,50 kg



STELLA DORATA

Lampada a sospensione in vetro, con disco decorativo in vetro
Pendant LED luminaire in glass, with decorative plate in glass

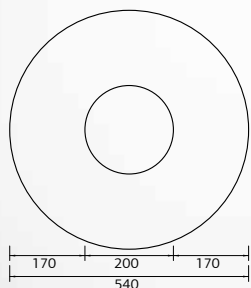
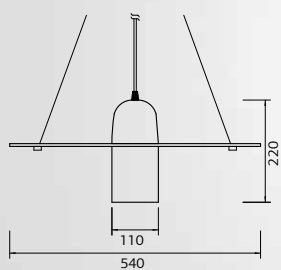

LED E27 – excluded lamp – 230Vac **CE**
Peso / Weight 3,50 kg

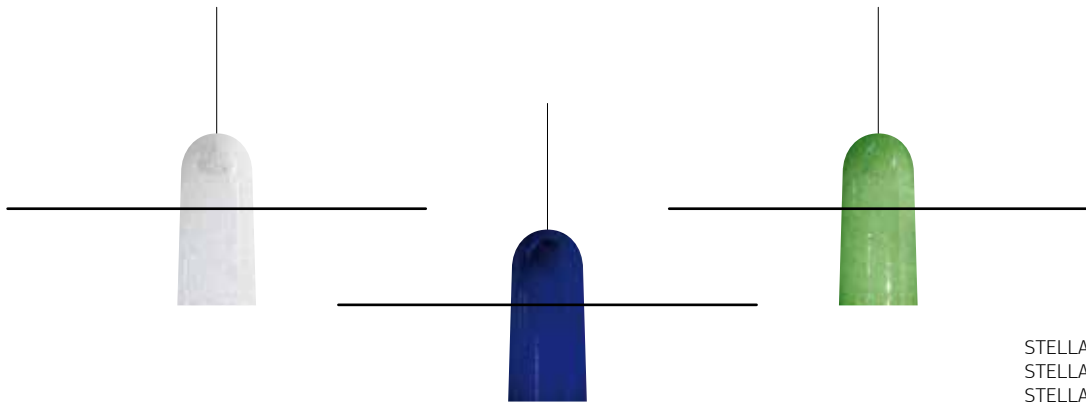

STELLA transparent
STELLA blue
STELLA green

STELLA VETRO

Lampada a sospensione in vetro, con disco decorativo in vetro
Pendant LED luminaire in glass, with decorative plate in glass

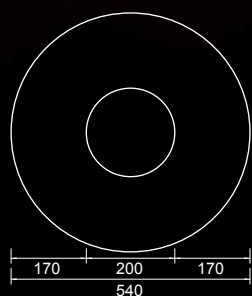
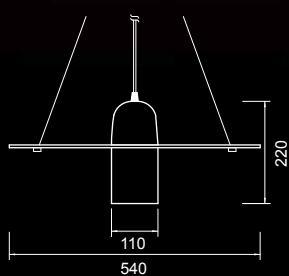

LED E27 – excluded lamp – 230Vac 
Peso / Weight 3,50 kg

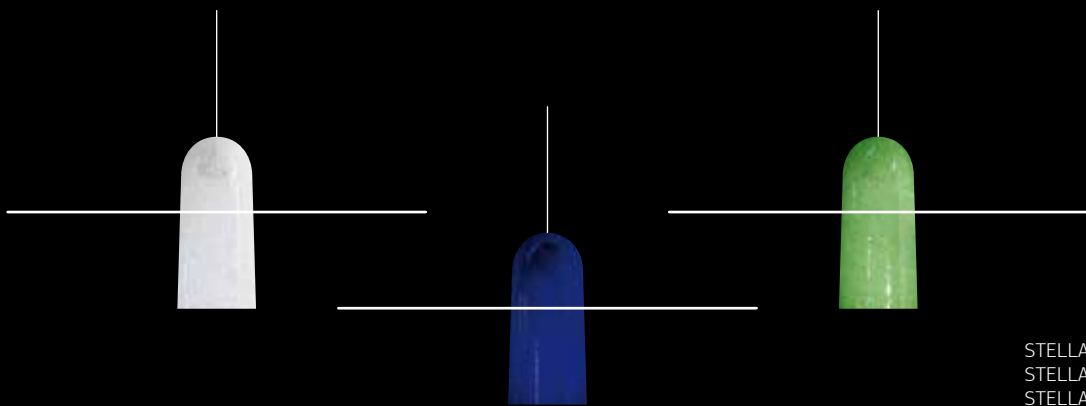

STELLA transparent
STELLA blue
STELLA green

STELLA METAL

Lampada a sospensione in vetro, con disco decorativo in metallo composito
Pendant LED luminaire in glass, with decorative plate in combined metal

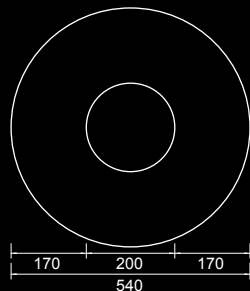
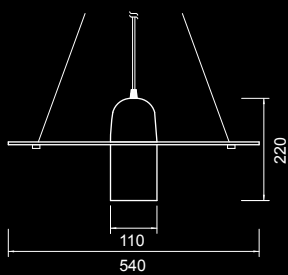

LED E27 – excluded lamp – 230Vac 
Peso / Weight 3,50 kg

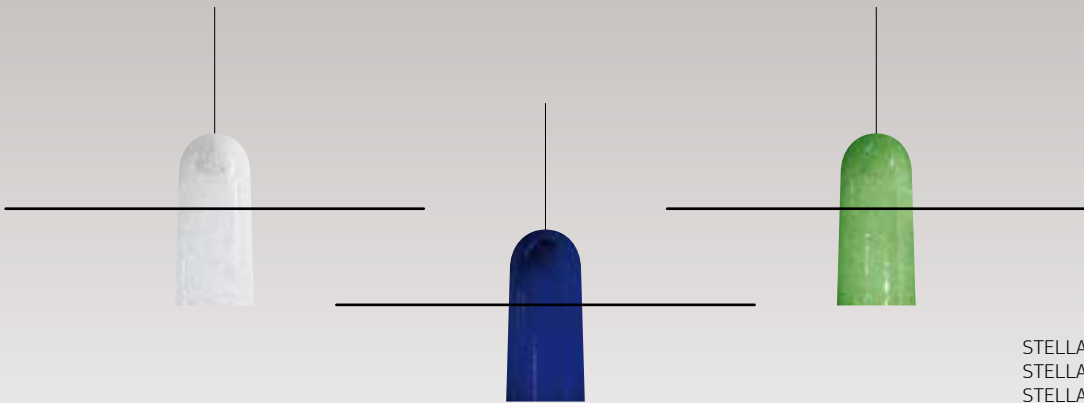

STELLA transparent
STELLA blue
STELLA green

DIVETRO 9 WOOD wall / ceiling

Lampada a led con vetro diffusore opale, incollato. Cornice decorativa in legno naturale, ricavato da travi centenarie, smontate da vecchi edifici.

Led luminaire with matt glass diffuser; the glass is glued to achieve a perfect shape. Frame is in natural wood; it is obtained from centennial wooden beams we found out in old buildings during renovations.

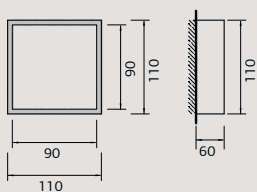

DIVETRO 9 WOOD
Led 5W – 230Vac – 3000K **CE**
Peso / Weight 0,45 kg



DIVETRO 18 WOOD wall / ceiling

Lampada a led con vetro diffusore opale, incollato. Cornice decorativa in legno naturale, ricavato da travi centenarie, smontate da vecchi edifici.

Led luminaire with matt glass diffuser; the glass is glued to achieve a perfect shape. Frame is in natural wood; it is obtained from centennial wooden beams we found out in old buildings during renovations.

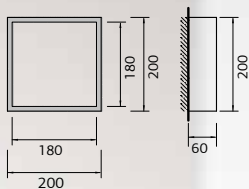

DIVETRO 18 WOOD
Led 17W – 230Vac – 3000K **CE**
Peso / Weight 0,9 kg

DIVETRO 33 WOOD wall / ceiling

Lampada a led con vetro diffusore opale, incollato. Cornice decorativa in legno naturale, ricavato da travi centenarie, smontate da vecchi edifici.

Led luminaire with matt glass diffuser; the glass is glued to achieve a perfect shape. Frame is in natural wood; it is obtained from centennial wooden beams we found out in old buildings during renovations.

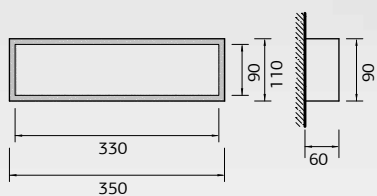

DIVETRO 33 WOOD
LED 9W – 230Vac – 3000K **CE**
Peso / Weight 0,9 kg

DIVETRO 9

Lampada in vetro a led, diffusore opale incollato. Da parete o soffitto
Led luminaire for wall or ceiling installation in glass.

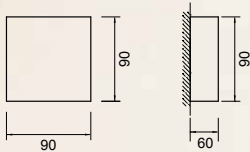

DIVETRO 9
Led 5W – 230Vac – 3000K **CE**
Peso / Weight 0,3 kg

DIVETRO 9 - 18 - 33

Lampada in vetro a led, diffusore opale incollato. Da parete o soffitto
Led luminaire for wall or ceiling installation in glass.

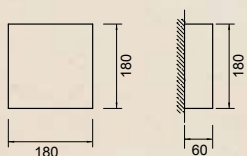
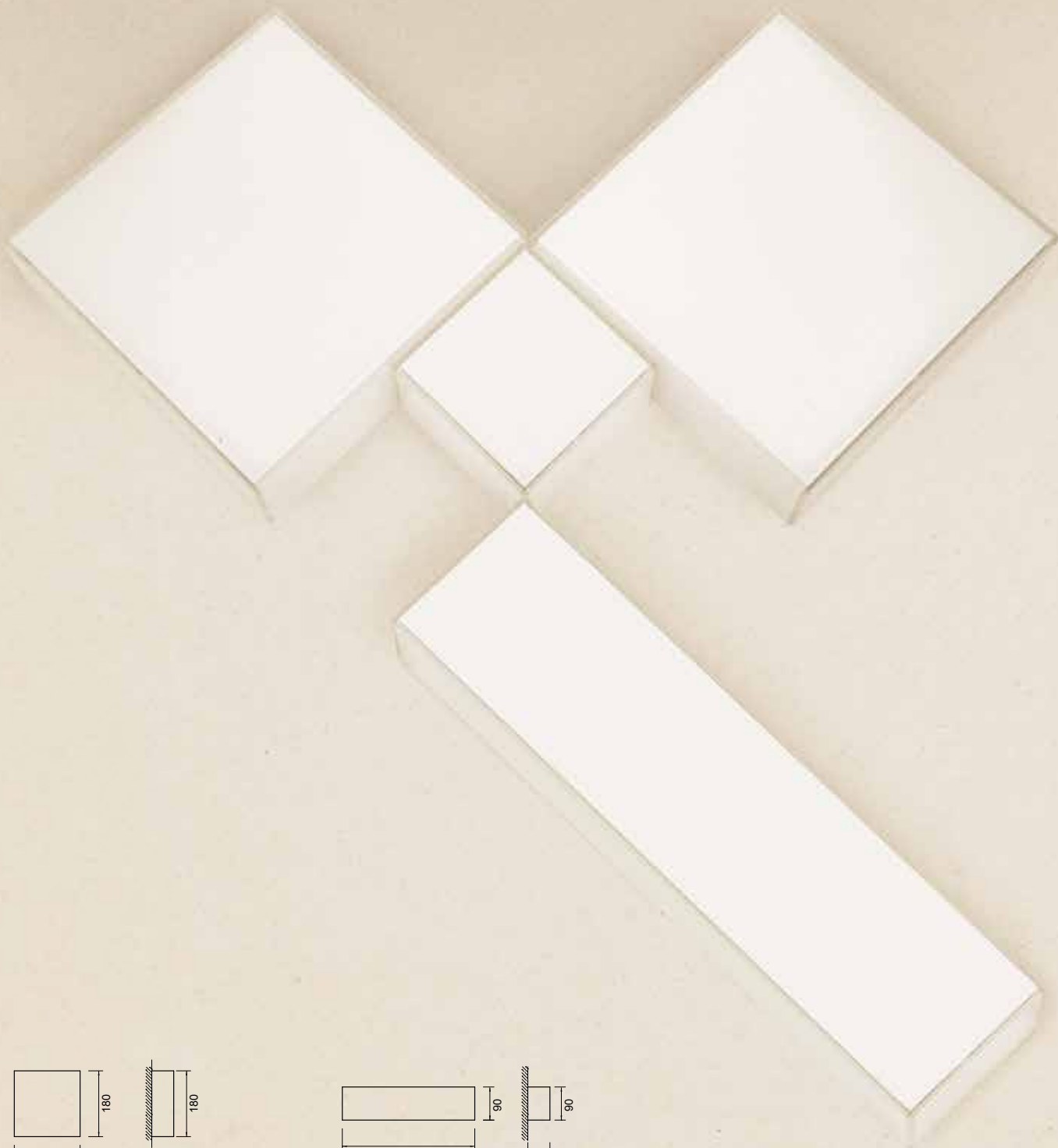

DIVETRO 18
Led 17W - 230Vac - 3000K **CE**
Peso / Weight 0,75 kg

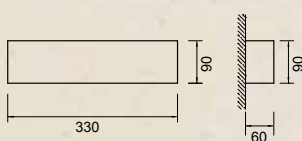

DIVETRO 33
Led 9W - 230Vac - 3000K **CE**
Peso / Weight 0,75 kg

COLORVETRO 9 - 18

Apparecchio in vetro con diffusore opale serigrafato, incollato. Lampada a led.
Su richiesta si eseguono serigrafie personalizzate.

Led luminaire in glass, for wall installation. Decorative diffuser, opal, with serigraphy.
Customized serigraphy on request.

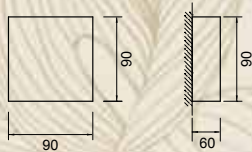

COLORVETRO 9
Led 5W - 230Vac - 3000K **CE**
Peso / Weight 0,4 kg

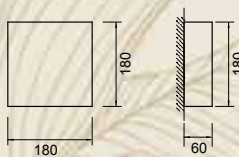

COLORVETRO 18
Led 17W - 230Vac - 3000K **CE**
Peso / Weight 0,8 kg



COLORVETRO 33

Apparecchio in vetro con diffusore opale serigrafato, incollato.
Lampada a led.
Su richiesta si eseguono serigrafie personalizzate.

Led luminaire in glass, for wall installation.
Decorative diffuser, opal, with serigraphy.
Customized serigraphy on request.

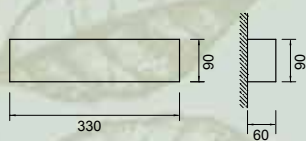

COLORVETRO 33
Led 9W – 230Vac – 3000K **CE**
Peso / Weight 0,8 kg





CERAMICA

CERAMIC

LA CERAMICA

Bassano e Nove sono territori famosi per la lavorazione della ceramica. I fattori che dal XVII secolo hanno favorito la nascita e lo sviluppo dell'arte della ceramica sono molteplici, tra questi la presenza nel sottosuolo di argilla plastica, saldame e caolino e la vicinanza al fiume Brenta. I nostri prodotti vogliono raccontare la nostra storia, quella della tradizione artigianale e del fatto a mano che si evolve con l'applicazione della nuova tecnologia a led.

CERAMIC

These pieces are unique, locally handmade taking in consideration the long history of ceramic in Bassano and Nove. There are several elements that have supported the origin and development of the ceramic art since the 17th century in our territory. Among them the availability of plastic clay and kaolin in the subsoil and the Brenta river. Our products tell about us and our history, a long tradition of competences that evolves in combination with the new led technologies.



Lampade in ceramica

Ceramic luminaires

in collaboration with

MAESTRI ARTIGIANI BASSANESI

Made in Italy



Premio ARTE 2017

Giuseppe Facchinello l'artista che ha creato le lampade in ceramica per ENGI è stato recentemente premiato con la Targa d'oro risultando vincitore del Premio ARTE 2017 per la sezione scultura. Le sue opere sono state esposte nella prestigiosa sede milanese di Palazzo Reale.

"ARTE" PRIZE 2017

Giuseppe Facchinello creates with ENGI srl ceramic luminaires. He won the "PREMIO ARTE 2017" in Milan. His creations has been shown in Palazzo Reale, Milano.

**Nasce il Novettino
ogni pezzo
unico e diverso**





La passione, l'idea, l'abilità delle mani.

Questa serie di prodotti in ceramica si contraddistingue per oggetti con il profilo umano. Con questa scelta si vuole ricordare che la persona umana rimane centrale e che continua ad esprimere sentimenti, arte, poesia e felicità anche in un periodo storico dove la tecnica, i robot e la digitalizzazione sembrano essere le uniche risorse vincenti.

This handmade family in ceramic is characterized by the human face. This is a choice we have done on purpose in order to keep the human being at the center and as the key of our lives. It express emotions, art, poetry and happiness even if we are living a historical period where techniques, robots and digital development seem to be the unique resources to improve lives.

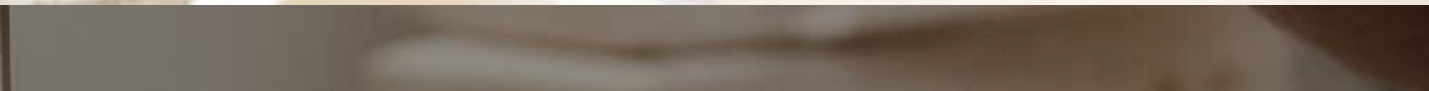

TWIST

Lampada a sospensione con corpo principale in ceramica e parte superiore in vetro soffiato.
La forma avvolgente e la finitura a solchi catturano la luce in un gioco di luce e ombre, creando un dinamismo senza fine alla materia.

Pendant LED luminaire with body in ceramic and superior part in blown glass.
The combination of this type of shape and the grooved finishing produces a dance of light and shadows, material lives with an everlasting dynamism.



TWIST white, bronze, graphite grey
LED E27 – excluded lamp – 230Vac **CE**
Peso / Weight 1 kg



MATERICA

Lampada a sospensione con corpo in ceramica e parte superiore in vetro soffiato. La finitura granulosa crea giochi di luce e ombre che fanno risaltare gli elementi naturali utilizzati nella costruzione. Tutti i materiali e i colori sono grezzi e naturali.

Pendant led luminaire with body in ceramic and superior part in blown glass.
The grainy finishing creates reflections of light and shadows that highlight all natural elements. All materials and colors are raw and natural.

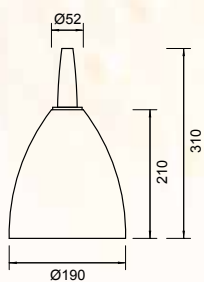

MATERICA yellow, brown, blue
LED E27 – excluded lamp – 230Vac **CE**
Peso / Weight 1,5 kg



LELLO

Lampada a sospensione in ceramica. La finitura superficiale granulosa crea riflessi di luce e ombre che fanno risaltare gli elementi naturali utilizzati nella costruzione.

Pendant LED luminaire in ceramic. The grainy finishing creates reflections of light and shadows that highlight all natural elements. All materials and colors are raw and natural.

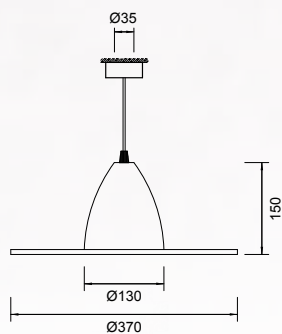

LELLO yellow, brown
LED E27 – excluded lamp – 230Vac **CE**
Peso / Weight 2,5 kg



CROCCO

Lampada a sospensione in ceramica.
Pendant LED luminaire in ceramic, handmade.

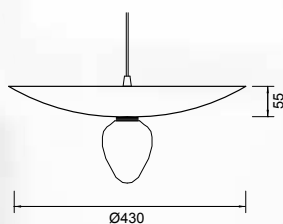

CROCCO bronze, white
LED E27 – excluded lamp – 230Vac **CE**
Peso / Weight 1,5 kg



NILLO

Lampada a sospensione, con struttura portante in metallo verniciato nero o oro e parte esterna in ceramica lavorata a mano.

Pendant LED luminaire with main body in black or gold painted metal and exterior cover in ceramic, handmade.

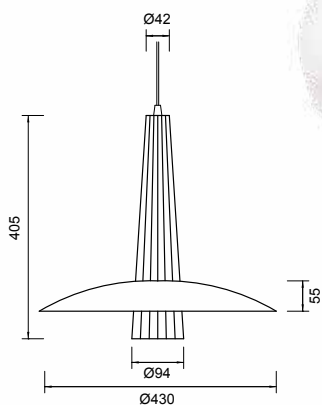
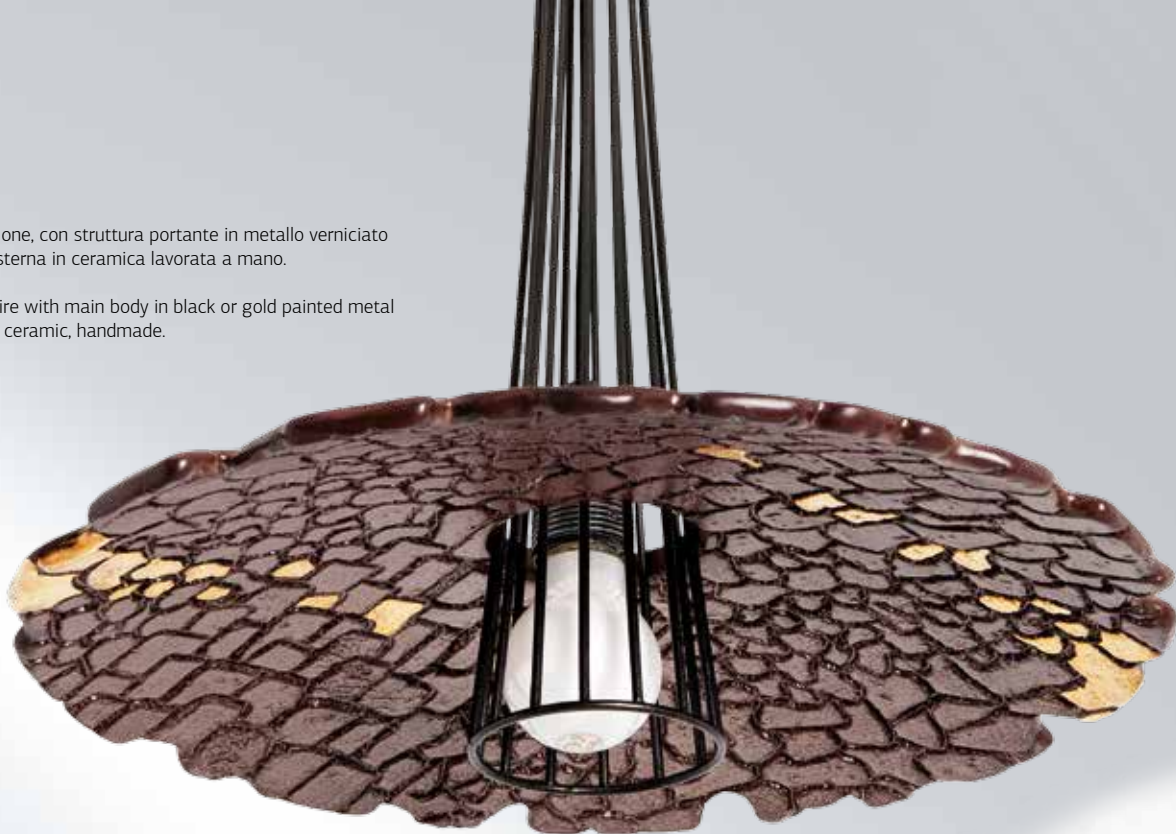

NILLO bronze, white
LED E27 – excluded lamp – 230Vac **CE**
Peso / Weight 4,4 kg



NILLO

Lampada a sospensione, con struttura portante in metallo verniciato nero o oro e parte esterna in ceramica lavorata a mano.

Pendant LED luminaire with main body in black or gold painted metal and exterior cover in ceramic, handmade.



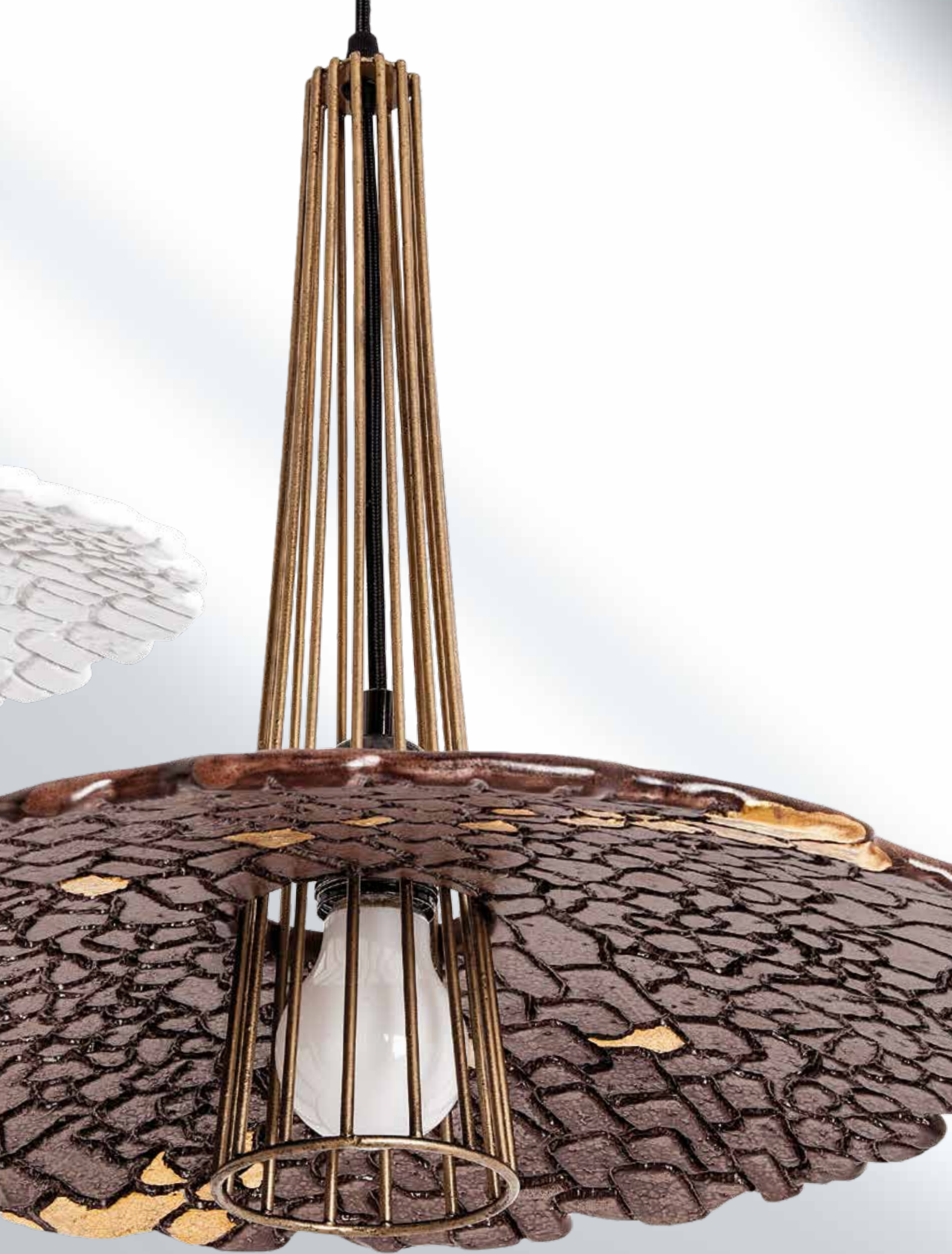



STRAPPO

Lampada a sospensione, con struttura portante in metallo verniciato nero o oro e parte esterna in ceramica lavorata a mano.

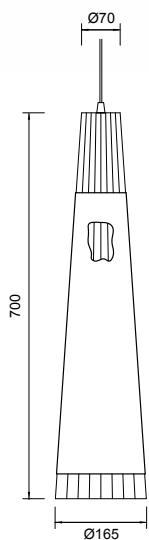
Pendant LED luminaire with main body in black or gold painted metal and exterior cover in ceramic, handmade.



STRAPPO bronze, white
LED E27 – excluded lamp – 230Vac 
Peso / Weight 8,5 kg



VASAI0

Lampada a sospensione in ceramica
Pendant luminaire in ceramic.

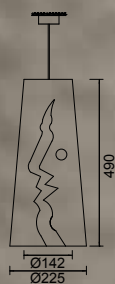

VASAI0 bronze, white
LED E27 - excluded lamp - 230Vac **CE**
Peso / Weight 3,45 kg



ELETTRA pendant

Lampada a sospensione in ceramica con finiture in vetro blu fuso.
Pendant luminaire in ceramic with blue molten finishing in glass.

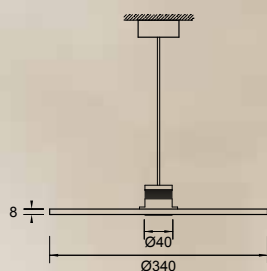
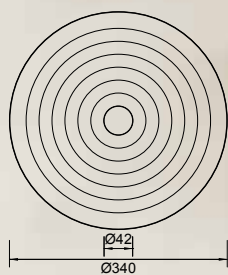

ceiling

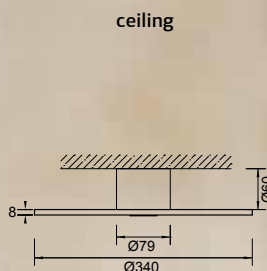

wall

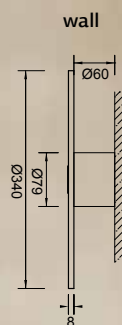

ELETTRA blue
LED E27 - excluded lamp - 230Vac **CE**
Peso / Weight 1,30 kg

ELETTRA blue
LED E27 - excluded lamp - 230Vac **CE**
Peso / Weight 1,40 kg

ELETTRA wall / ceiling

Lampada a parete in ceramica con finiture in vetro blu fuso.
Wall or ceiling luminaire in ceramic with blue molten finishing in glass.



ARTU'

Lampada a sospensione in ceramica. Distribuzione della luce verso l'alto e verso il basso.
Pendant LED luminaire in ceramic. Direct and indirect light.

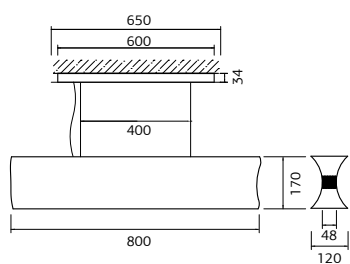
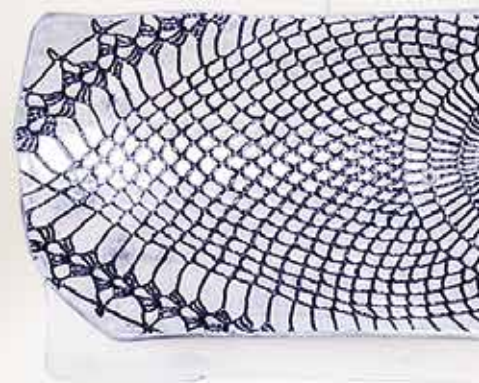
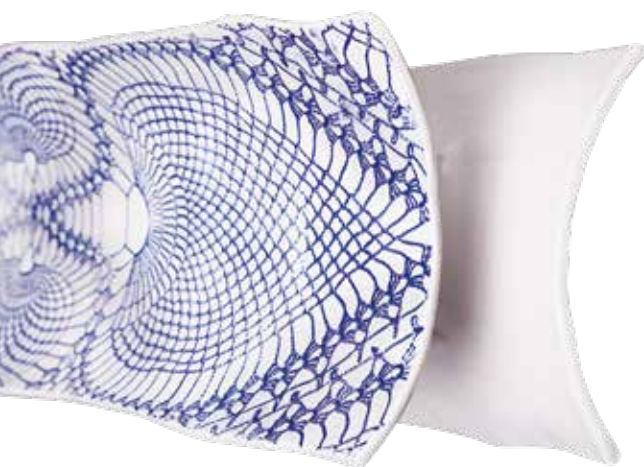

ARTU' blue
LED 20+20W – 230Vac – 3000K – 24V **CE**
Driver included
Peso / Weight 8,6 kg

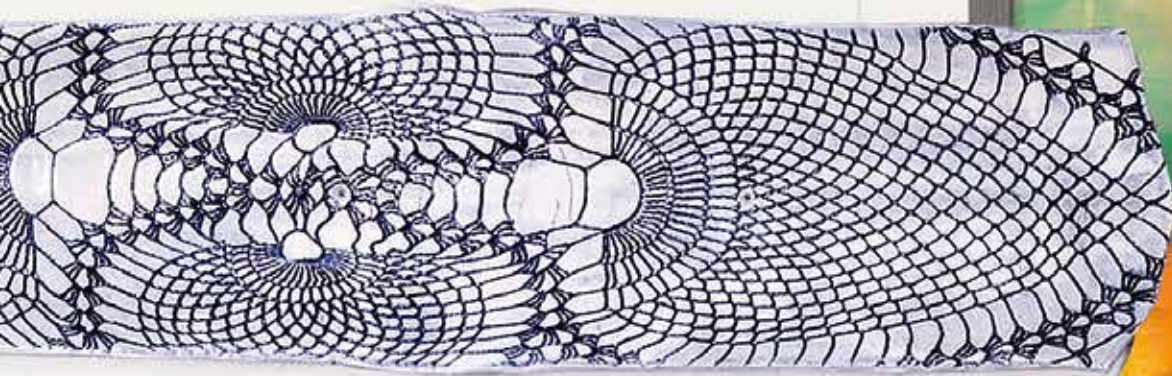

SANMARTINO

Lampada a sospensione in ceramica.
Pendant LED luminaire in ceramic.



SANMARTINO venetian red, graphite grey
LED E27 - excluded lamp - 230Vac **CE**
Peso / Weight 1,9 kg



NOVE pendant

Lampada a sospensione e a soffitto in ceramica.
Ceiling or pendant luminaire in ceramic handmade.

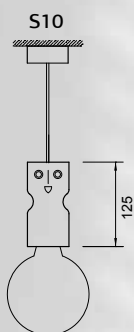
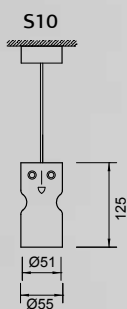

NOVE venetian red, graphite grey
LED E27 - excluded lamp - 230Vac **CE**
Peso / Weight 0,30 kg

NOVE venetian red, graphite grey
LED GU10 - excluded lamp - 230Vac **CE**
Peso / Weight 0,30 kg



NOVETTINO

Lampada a sospensione in ceramica.
Pendant LED luminaire in ceramic, handmade.

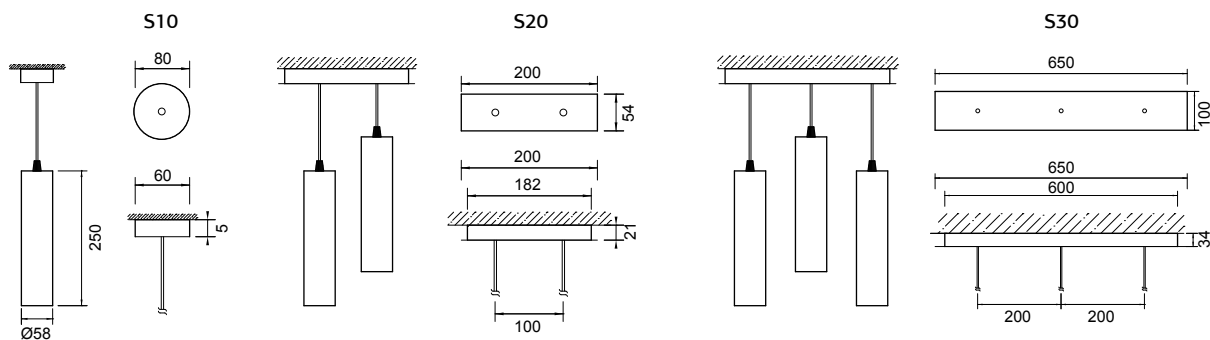



NOVETTINO venetian red, graphite grey
LED GU10 - excluded lamp - 230Vac **CE**
Peso / Weight 0,40 kg

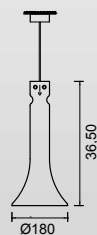

SBARAZZINA pendant

Lampada a sospensione in ceramica.
Pendant LED luminaire in ceramic, handmade.



SBARAZZINA venetian red, graphite grey
LED E27 - excluded lamp - 230Vac 
Peso / Weight 0,95 kg



SBARAZZINA table

Lampada da tavolo in ceramica
Table luminaire in ceramic, handmade.

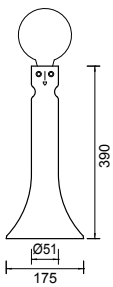

SBARAZZINA venetian red, graphite grey
LED E27 - excluded lamp - 230Vac **CE**
Peso / Weight 0,95 kg



NOVELLA table

Lampada da tavolo in ceramica.
Table luminaire in ceramic, handmade.

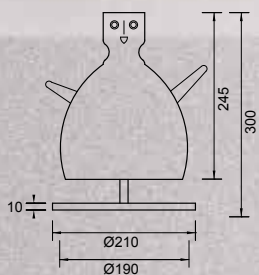

NOVELLA venetian red, graphite grey
LED 17W - 230Vac - 3000K **CE**
Peso / Weight 3,10 kg

NOVELLA pendant

Lampada a sospensione in ceramica.
Pendant LED luminaire in ceramic, handmade.

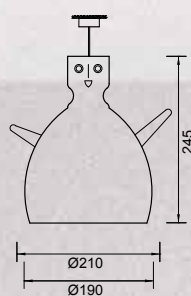

NOVELLA venetian red, graphite grey
LED E27 - excluded lamp - 230Vac **CE**
Peso / Weight 1,90 kg

AMELIE table

Lampada da tavolo in ceramica.
Table luminaire in ceramic, handmade.

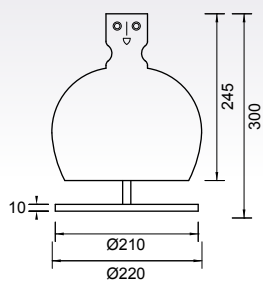

AMELIE venetian red, graphite grey
LED 17W - 230Vac - 3000K **CE**
Peso / Weight 3 kg

AMELIE pendant

Lampada a sospensione in ceramica.
Pendant LED luminaire in ceramic, handmade.

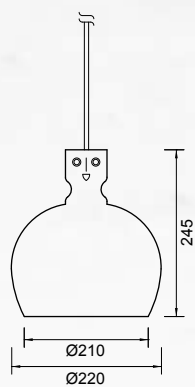

AMELIE venetian red, graphite grey
LED E27 - excluded lamp - 230Vac **CE**
Peso / Weight 1,8 kg

COCÒ wall

Lampada a parete in ceramica stile rococò, luce indiretta.
Wall luminaire in ceramic, rococò style, indirect light.

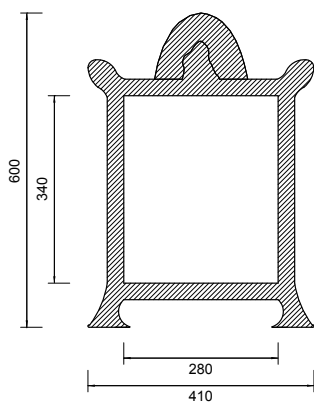
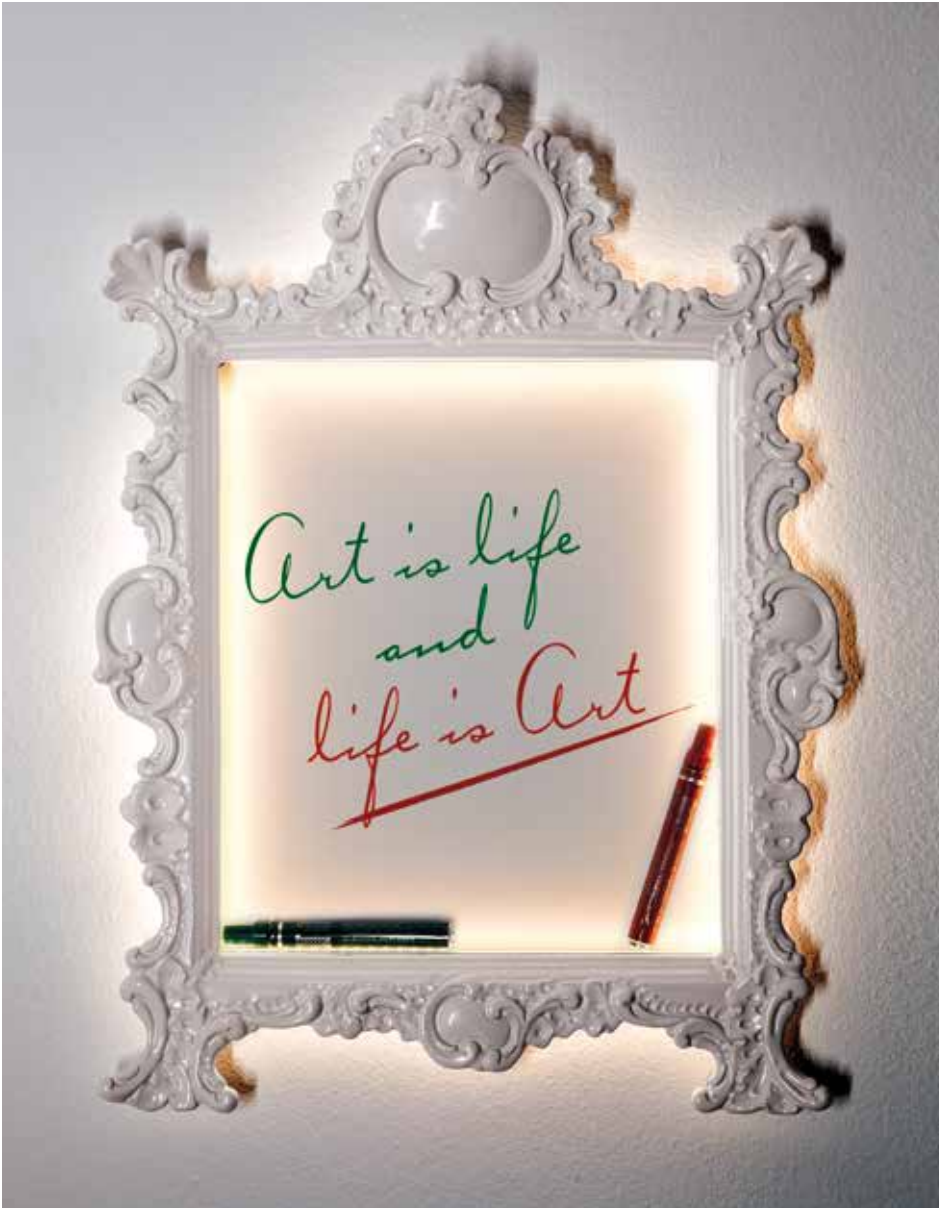

COCÒ' white, black, gold
LED 20W – 3000K – 24V **CE**
Driver included
Peso / Weight 1,3 kg



COCÒ pendant

Lampada a sospensione in ceramica, stile rococò.
Pendant LED luminaire in ceramic, rococò style.

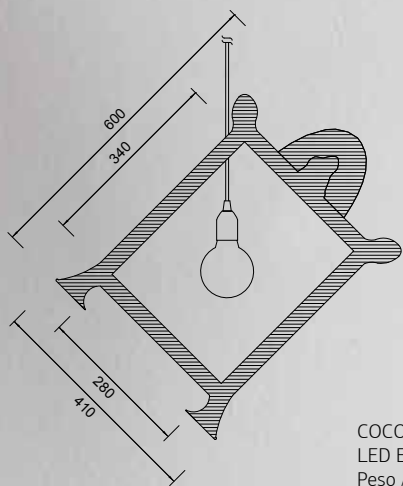

COCO' white, black, gold
LED E27 - excluded lamp - 230Vac **CE**
Peso / Weight 1,3 kg



SERVO MUTO

Lampada da terra in ceramica, con base circolare in acciaio verniciato. Funzioni multiple; combina l'illuminotecnica con il sostegno di oggetti leggeri. L'effetto è unico per dimensioni e rifiniture fatte completamente a mano con colori che creano sensazioni uniche. Collegamento elettrico con interruttore a piede.

Floor luminaire in ceramic with a round base in painted steel. It can be a luminaire but also an hanger for light clothes and objects. Handmade with special effects created by color matching. Electrical connection with switch.

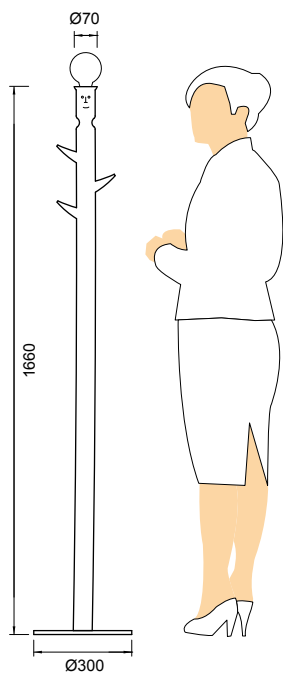

LED E27 – excluded lamp – 230Vac **CE**
Peso / Weight 13,5 kg





GOCCE DI RUGIADA

Lampada da terra in ceramica, con base di appoggio a terra in legno naturale, composta da 7 gambi in ceramica ricavati da estrusione della materia grezza, dipinti a mano con terre colorate e cotti al forno. Alle estremità lampadine a led di varie dimensioni. La composizione, dalle forme floreali, emana riflessi di luce e ombre grazie alla superficie rugosa la quale è stata impreziosita anche da cristalli di rugiada Swarovski. Oggetto fortemente emozionale che utilizza tutti componenti naturali e crea una simbiosi tra la natura e la tecnica conservando un design unico e non replicabile.

Floor luminaire in ceramic with base in natural wood. It is composed by seven ceramic stems, all of them are handmade from a unique piece of raw material, colored by hand and cooked in furnace. Led luminaire and Swarovsky diamonds as decorative accessories. It is not only a luminaire, not only a statue, but a unique masterpiece between architecture and nature.

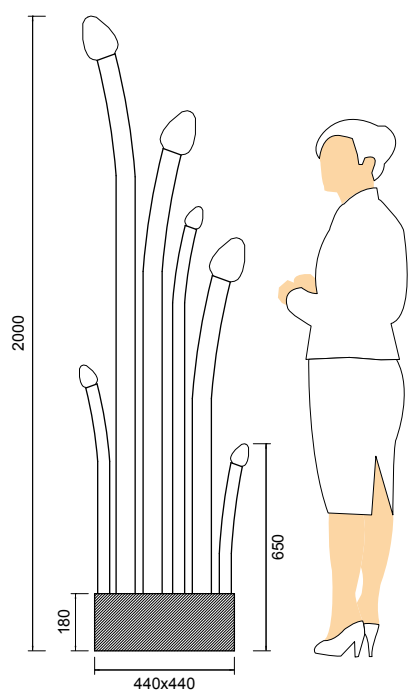

Portalampada
LED 3xE27 e 4xE14 - excluded lamp - 230Vac **CE**
Peso / Weight 35 kg









METALLO

METAL

bianco
white

nero
black

oro
gold

rame
copper

corten

bronzo
bronze



Lampade con
finiture in metallo
*Luminaires in
metal*

LUNA PIENA

Lampada a sospensione in alluminio di forma circolare. Il design minimalista e le numerose finiture la rendono facilmente adattabile a qualsiasi arredamento.

Pendant LED luminaire in aluminium, round shape. Simple design and several finishings make this luminaire suitable for any environment.

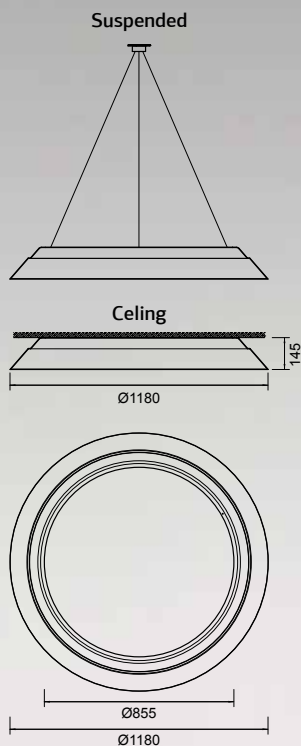

LUNA PIENA white, painted, on request
LED 30W - 4000K - 24V **CE**
Driver included
Peso/Weight 1 kg



ZOPPA

Lampada a sospensione composta da due elementi piani asimmetrici in metallo, che distribuiscono la luce in modo diretto ed indiretto.

Pendant luminaire in metal, composed by two asymmetrical plates. Direct and indirect light.

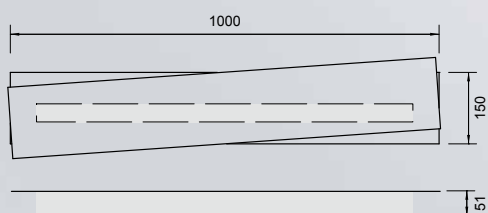

ZOPPA silver grey
LED 20W – 3000K – 24V **CE**
Driver included
Peso/Weight 3,5 kg



TUTTONDO

Lampada a sospensione di forma circolare in alluminio, acciaio o metallo composito verniciato ottone. Completo di cavetti in acciaio e attacco per sospensione al soffitto.

Pendant LED luminaire with a round shape, in aluminium, steel or combined metal with brass finish. It is supplied with steel cables and installation accessories.

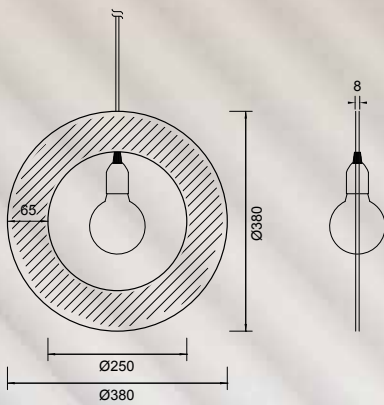

TUTTONDO brass
LED E27 - excluded lamp - 230Vac **CE**
Peso / Weight 1 kg



LEGO ceiling

Apparecchio a soffitto con corpo in acciaio verniciato bianco o nero. GU10 o E27, lampada esclusa.

Ceiling luminaire in steel material with white or black finishing. GU10 or E27, lamp not included.



LEGO pendant

Apparecchio a sospensione con corpo in acciaio verniciato bianco o nero. GU10 o E27, lampada esclusa.

Pendant luminaire in steel material with white or black finishing. GU10 or E27, lamp not included.

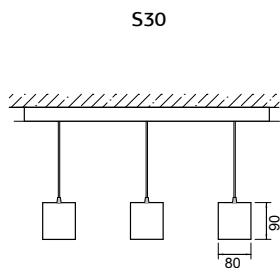
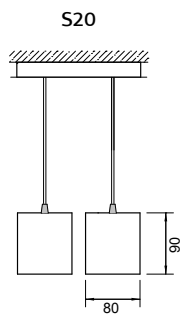
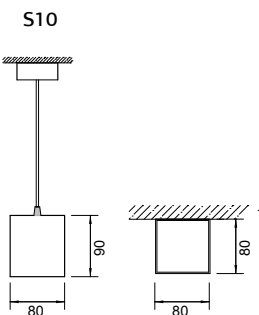

LEGO ceiling and pendant white, black
LED GU10 - excluded lamp - 230Vac **CE**
Peso / Weight 0,28 kg

LEGO ceiling and pendant white, black
LED E27 - excluded lamp - 230Vac **CE**
Peso / Weight 0,28 kg

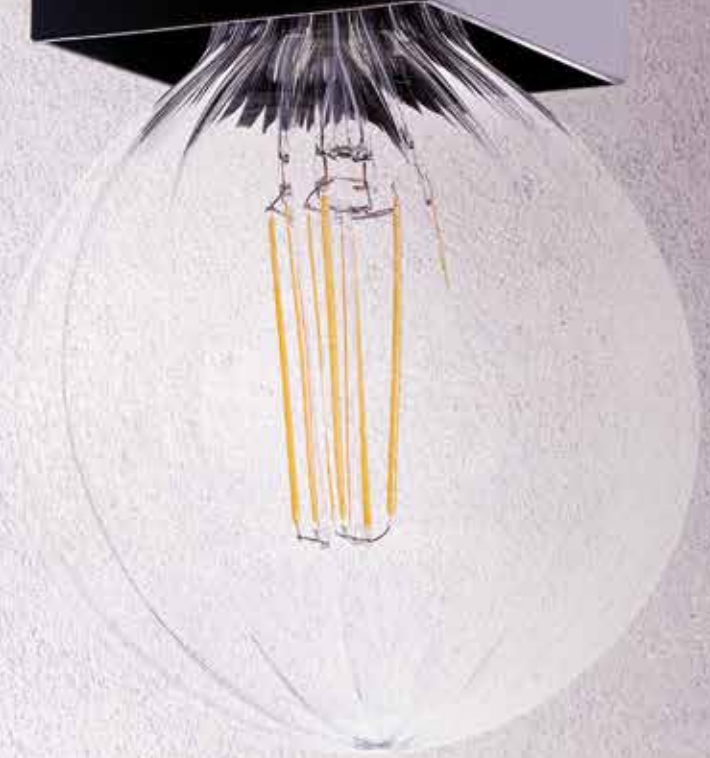

RULLO ceiling

Apparecchio a soffitto con corpo in acciaio verniciato bianco o nero. GU10 o E27, lampada esclusa.

Ceiling luminaire in steel material, white or black finishing. GU10 or E27, lamp not included.

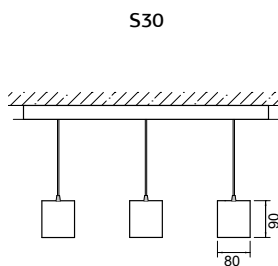
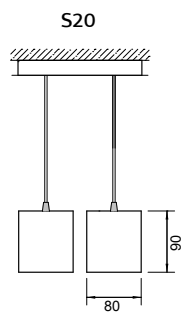
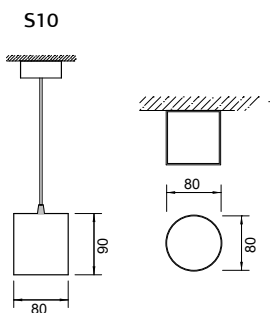

RULLO ceiling and pendant white, black
LED GU10 - excluded lamp - 230Vac **CE**
Peso / Weight 0,28 kg

RULLO pendant

Apparecchio a sospensione con corpo in acciaio verniciato bianco o nero. GU10 o E27, lampada esclusa.

Pendant luminaire in steel material, white or black finishing. GU10 or E27, lamp not included.

RULLO ceiling and pendant white, black
LED E27 - excluded lamp - 230Vac **CE**
Peso / Weight 0,28 kg



MINIMAL A + MINIMAL A with glass

Lampada a sospensione in acciaio verniciato con o senza accessorio in vetro opale.
Pendant luminaire made in steel with or without opal glass accessory.

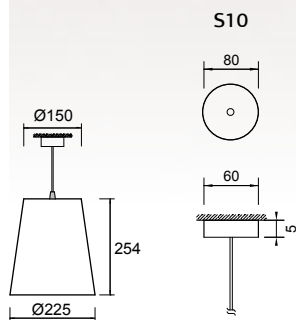



MINIMAL A white, black or gold
MINIMAL A with glass opal glass
LED E27 - excluded lamp - 230Vac **CE**
Peso / Weight 1,2 kg

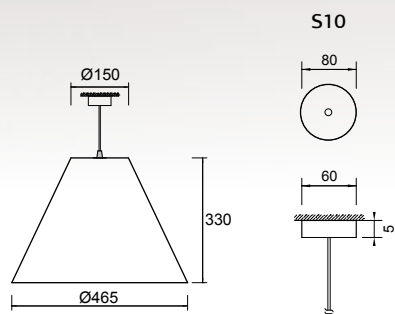

MINIMAL B + MINIMAL B with glass

Lampada a sospensione in acciaio verniciato con o senza accessorio in vetro blu.
Pendant luminaire made in steel with or without blue glass accessory.



MINIMAL B white, black or gold
MINIMAL B with glass blue glass
LED E27 - excluded lamp - 230Vac 
Peso / Weight 1,5 kg



MINIMAL C + MINIMAL C with glass

Lampada a sospensione in acciaio verniciato con o senza accessorio in vetro trasparente.
Pendant luminaire made in steel with or without transparent glass accessory.

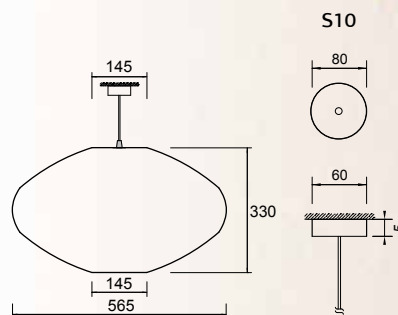

MINIMAL C black or gold
MINIMAL C with glass transparent glass
LED E27 - excluded lamp - 230Vac **CE**
Peso / Weight 2,5 kg



ARMONIA wall

Lampada a LED ad installazione a parete, corpo in alluminio e diffusore microprismatico. Luce diretta e indiretta.

Wall LED luminaire, body in aluminium and microprismatic diffuser. Direct and indirect light.

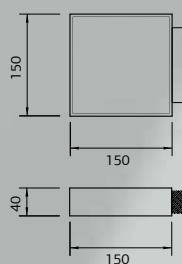

ARMONIA white, bronze, blue
LED 17W – 230Vac – 3000K **CE**
Peso / Weight 0,76 kg



ARMONIA wall

Lampada a LED ad installazione a parete, corpo in alluminio e diffusore microprismatico. Luce diretta e indiretta.

Wall LED luminaire, body in aluminium and microprismatic diffuser. Direct and indirect light.

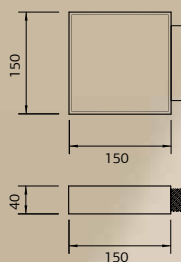

ARMONIA white, bronze, blue
LED 17W – 230Vac – 3000K **CE**
Peso / Weight 0,76 kg

ARMONIA twin wall

Lampada a LED ad installazione a parete, corpo in alluminio e diffusore microprismatico. Luce diretta e indiretta.

Wall LED luminaire, body in aluminium and microprismatic diffuser. Direct and indirect light.

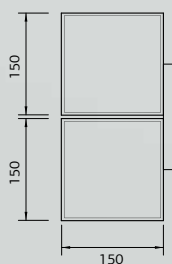

ARMONIA white, bronze, blue
LED 34W – 230Vac – 3000K **CE**
Peso / Weight 1,8 kg

ARMONIA pendant

Lampada a sospensione, corpo in alluminio e diffusore microprismatico. Luce diretta e indiretta.

Pendant LED luminaire, body in aluminium and microprismatic diffuser. Direct and indirect light.

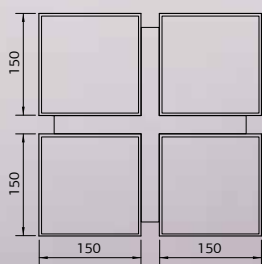



ARMONIA white, bronze, blue
LED 34W - 230Vac - 3000K **CE**
Peso / Weight 3,5 kg

ARMONIA pendant

Lampada a sospensione, corpo in alluminio e diffusore microprismatico. Luce diretta e indiretta.

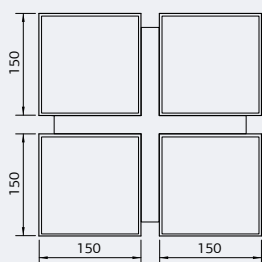
Pendant LED luminaire, body in aluminium and microprismatic diffuser. Direct and indirect light.



ARMONIA white, bronze, blue
LED 34W - 230Vac - 3000K 
Peso / Weight 3,5 kg



ARMONIA flora

Lampada a sospensione, corpo in alluminio e diffusore microprismatico. Luce diretta e indiretta.

Pendant LED luminaire, body in aluminium and microprismatic diffuser. Direct and indirect light.

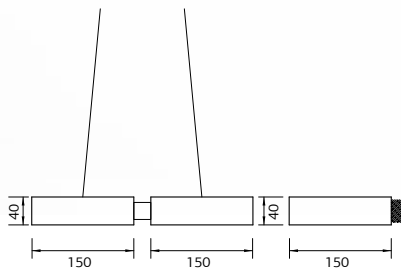

ARMONIA white, bronze, blue
LED 34W - 230Vac - 3000K **CE**
Peso / Weight 3,5 kg

PURA white

Lampada a LED da tavolo, in acciaio verniciato bianco.
LED table luminaire in white painted steel.

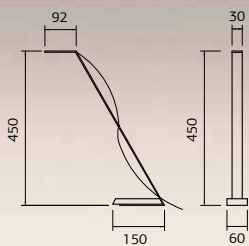

PURA white
LED 6W - 230Vac - 3000K **CE**
Peso / Weight 1,4 kg

PURA black

Lampada a LED da tavolo, in acciaio verniciato nero.
LED table luminaire in black painted steel.

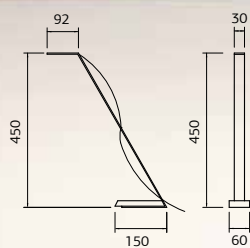

PURA black
LED 6W - 230Vac - 3000K **CE**
Peso / Weight 1,4 kg



SINUOSA

Apparecchio a LED da tavolo con luce morbida e continua, dimmerabile, con possibilità di direzionarla manualmente. Corpo in alluminio verniciato e diffusore in materiale plastico opale. La forma circolare e sinuosa si sviluppa in una continuità senza fine che rende questa lampada unica e priva di interruzioni, un oggetto scultoreo animato da una luce speciale nel panorama dell'illuminazione.

Table lamp with LED technology, soft and continuous light, dimmable. Body in painted aluminium and diffuser in opal plastic material. The shape is round and sinuous, an exclusive lamp without interruption, a linear sculpture with a light's soul.

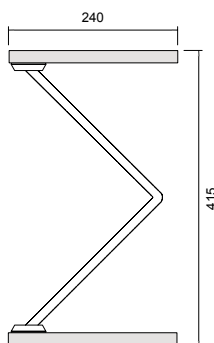

LED 18W – 230Vac – 3000K **CE**
Peso / Weight 2,27 kg



SOTTILE

Lampada a LED da terra. Base e sostegno in acciaio, finitura corten o su richiesta. Diffusore in vetro opale.

LED floor luminaire. Base and pole in steel, corten or on request. Opal diffuser in glass.

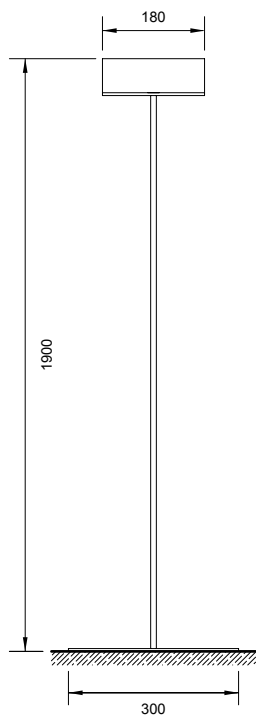

SOTTILE corten, on request
LED 17W – 230Vac – 3000K **CE**
Peso / Weight 8 kg



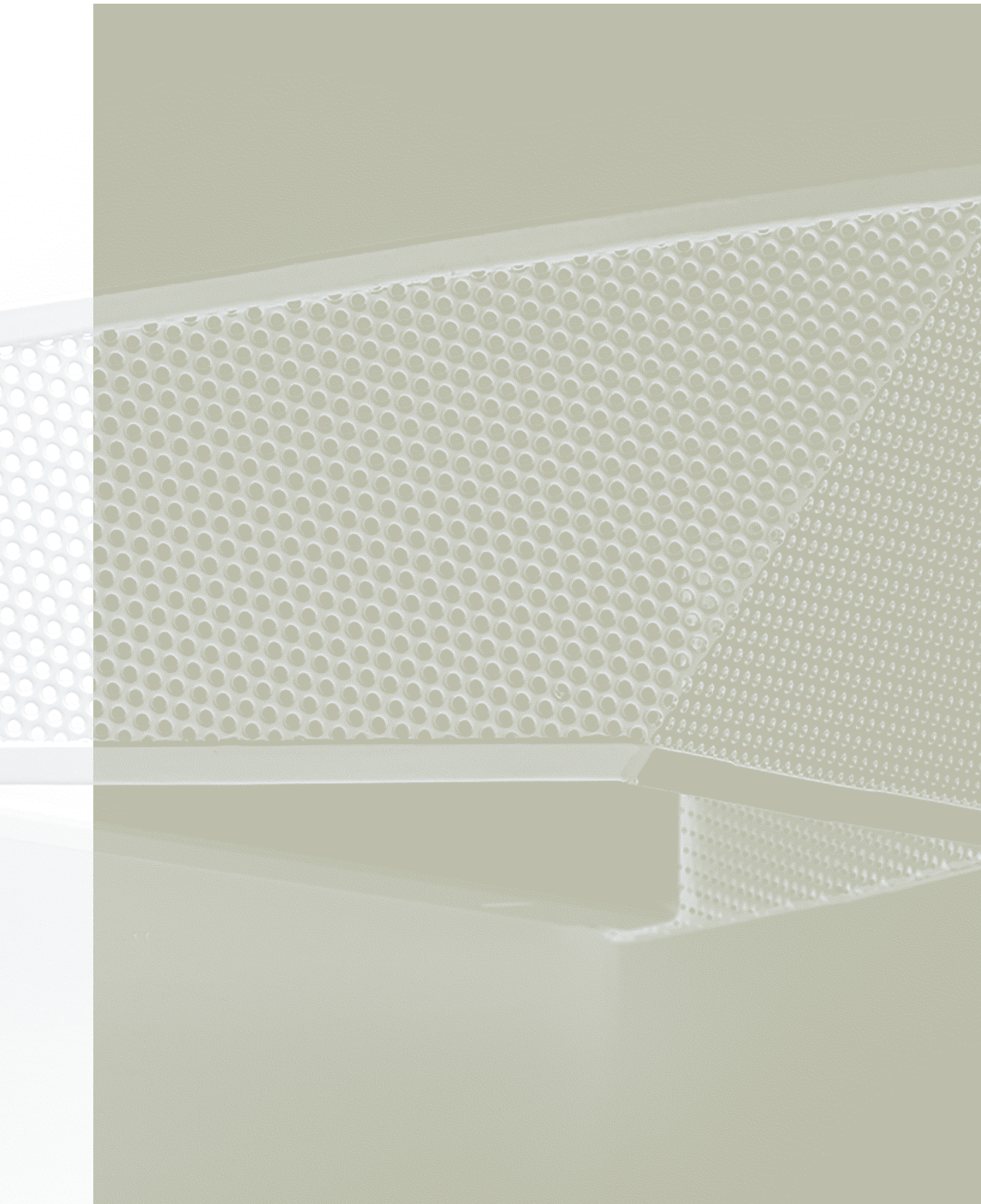



VARIO

OTHERS

BORGHESE wall

Lampada a led con paralume in tessuto colore bianco o a richiesta.
Wall luminaire with a textile shade in white colour. Other colours on request.

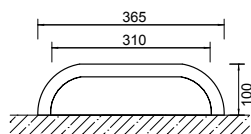
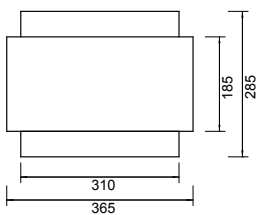

BORGHESE white, other on request
Nr. 4 socked - E27 - Excluded bulbs **CE**
Peso / Weight 0,76 kg

BORGHESE wall



ELLISSE ceiling

Apparecchio a soffitto con corpo di forma geometrica ellittica in metacrilato opale. Piastra di supporto in alluminio anodizzato verniciato bianco. Distribuzione luminosa priva di abbagliamento.

LED luminaire for ceiling or pendant installation. Body in opal methacrylate with a simple elliptic shape. Base for installation in white painted aluminium. Soft lighting without glare.

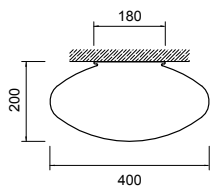

LED 18W – 230Vac – 3000K or 4000K **CE**
Peso / Weight 0,5 kg

ELLISSE pendant

Apparecchio a sospensione con corpo di forma geometrica ellittica in metacrilato opale. Piastra di supporto in alluminio anodizzato verniciato bianco. Distribuzione luminosa priva di abbagliamento. Bacchetta decorativa per apparecchio a sospensione nera o oro.

LED luminaire for ceiling or pendant installation. Body in opal methacrylate with a simple elliptic shape. Base for installation in white painted aluminium. Soft lighting without glare. Pendant decorative sticks in black or gold.

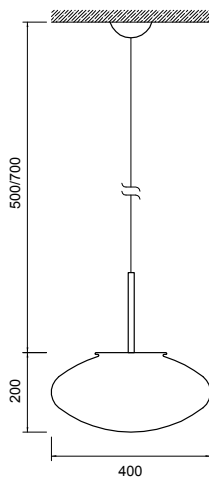

LED 18W – 230Vac – 3000K or 4000K **CE**
Peso / Weight 0,5 kg



SFERA ceiling

Apparecchio a soffitto con corpo di forma sferica in metacrilato opale. Piastra di supporto in alluminio anodizzato verniciato bianco. Distribuzione luminosa priva di abbagliamento.

LED luminaire for ceiling installation. Body in opal methacrylate with a simple geometrical shape. Base for installation in white painted aluminium. Soft lighting without glare.

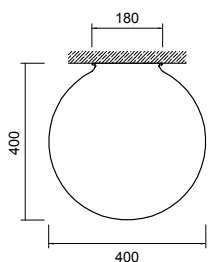

LED 18W – 230Vac – 3000K **CE**
Peso / Weight 0,3 kg

SFERA pendant

Apparecchio a sospensione con corpo di forma sferica in metacrilato opale. Piastra di supporto in alluminio anodizzato verniciato bianco. Distribuzione luminosa priva di abbagliamento. Bacchetta decorativa per apparecchio nera o oro.

LED luminaire for pendant installation. Body in opal methacrylate with a simple geometrical shape. Base for installation in white painted aluminium. Soft lighting without glare. Pendant decorative sticks in black or gold.

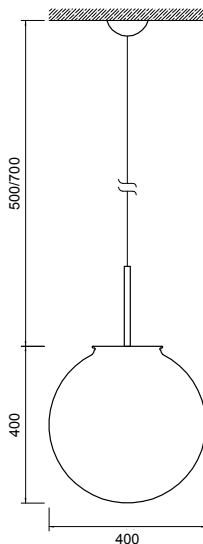

LED 18W – 230Vac – 3000K **CE**
Peso / Weight 0,3 kg



RIALTO wall

Apparecchio decorativo a LED per installazione a parete. Schermo decorativo bianco disponibile in diversi materiali: vetro opale, policarbonato o tessuto. Base di fissaggio a muro in alluminio. Distribuzione della luce morbida, senza abbagliamento. Luce diretta e indiretta.

LED luminaire for wall installation. Decorative white diffuser in opal glass, PMMA and textiles. Fixing base in aluminium for wall installation. Soft lighting without glare. Direct and indirect light.



RIALTO white or opal
LED 20W – 230Vac – 3000K **CE**
Peso / Weight 0,2 kg

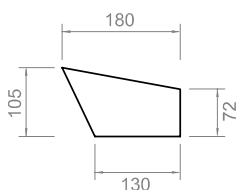
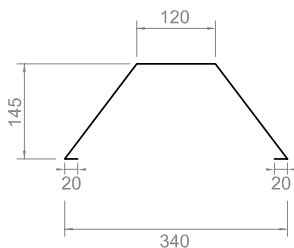
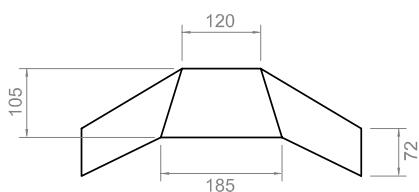

MASKERA perforated

Apparecchio a LED per installazione a parete. Schermo forato in metallo verniciato. Base di fissaggio a muro in alluminio. Distribuzione della luce morbida e omogenea. Luce diretta e indiretta.

LED luminaire for wall installation. Perforated diffuser in painted metal. Fixing base in aluminium for wall installation. Soft lighting, without glare. Direct and indirect light.



MASKERA white, red, silver grey
LED 20W – 230Vac – 3000K **CE**
Peso / Weight 0,4 kg

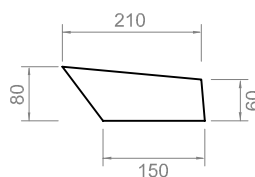
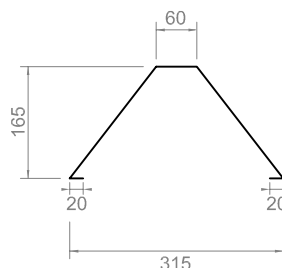
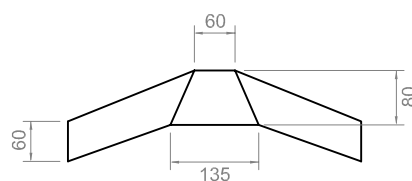

MASKERA full

Apparecchio a LED per installazione a parete. Schermo decorativo in metallo verniciato. Base di fissaggio a muro in alluminio. Distribuzione della luce morbida e omogenea. Luce diretta e indiretta.

LED luminaire for wall installation. Decorative diffuser in painted metal. Fixing base in aluminium for wall installation. Soft lighting, without glare. Direct and indirect light.



MASKERA white, red, silver grey
LED 20W – 230Vac – 3000K **CE**
Peso / Weight 0,4 kg

MASKERA full

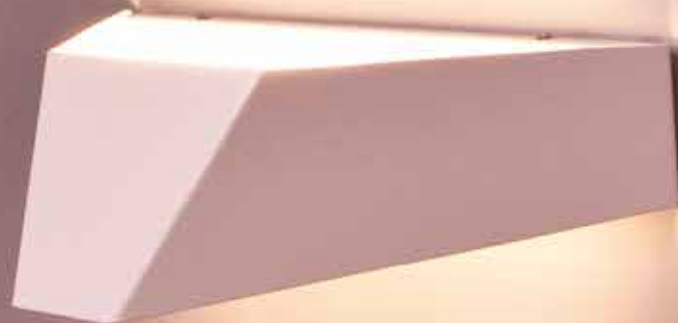

Lampadine a LED 230VAC CRI>80



G9 LED White 250°
Code: BNL1501170
Φ18x55mm
3,4W 345lm 3000K



G9 LED Clear 360°
Code: L00BS87042
Φ16x58mm
4W 400lm 3000K



GU10 LED White 36°
Code: L00BS630732
Φ50x54mm
6W 540lm 2700K



GU10 LED White 36°
Code: L00BS630732B
Φ50x54mm
6W 540lm 3000K



GU10 LED White 36°
Code: L00BS630733
Φ50x54mm
6W 540lm 4000K



E14 LED Opal
Code: L00BM20042
Φ45x80mm
4,5W 470lm 2700K



E14 LED Opal
Code: L00BM30042
Φ35x97mm
4,5W 470lm 2700K



E27 LED Opal
Code: L00BM31042
Φ45x78mm
4,5W 470lm 2700K



E27 LED Opal
Code: L00BM10082
Φ60x104mm
7,5W 806lm 2700K



E27 LED Opal
Code: L00BM42082
Φ95x140mm
7,5W 806lm 2700K



E27 LED Opal
Code: L00BM40082
Φ125x178mm
7,5W 806lm 2700K



E27 LED Opal
Code: L00BM40112
Φ125x178mm
11W 1521lm 2700K



E14 LED Clear
Code: BNL1502270
Φ45x79mm
4,8W 470lm DIM 2700K



E27 LED Clear
Code: BNL1501270
Φ60x104mm
4,6W 470lm 2700K



E27 LED Clear
Code: BNL1501370
Φ60x104mm
8,3W 806lm DIM 2700K



E27 LED Clear
Code: BNL1503670
Φ80x116mm
4,4W 470lm 2700K



E27 LED Clear
Code: BNL1503870
Φ95x137mm
7,7W 1055lm DIM 2700K



E27 LED Clear
Code: BNL1503970
Φ124x172mm
7,7W 1055lm DIM 2700K



E14 LED Golden
Code: BNL1502970
Φ45x79mm
1,2W 100lm 2200K



E27 LED Golden
Code: BNL1503170
Φ60x104mm
2,8W 200lm 2000K



E27 LED Golden
Code: BNL1503270
Φ80x116mm
2,8W 200lm 2000K



E27 LED Golden
Code: BNL1503570
Φ124x172mm
2,8W 200lm 2000K



E27 LED Avra Stripes Clear
Code: BNL1421070
Φ125x173mm
2W 150lm 2200K



E27 LED Avra Stripes Amber
Code: BNL1422070
Φ125x173mm
2W 140lm 2200K



E27 LED Avra Stripes Smoked
Code: BNL1426070
Φ125x180mm
2W 130lm 2200K



E27 LED Avra Bamboo Smoked
Code: BNL1427070
Φ125x177mm
2W 130lm 2200K



E27 LED Avra Square Amber
Code: BNL1428070
Φ120x177mm
2W 140lm 2200K



E27 LED Avra Dent Smoked
Code: BNL1429070
Φ125x177mm
2W 130lm 2200K



E27 LED Avra Nut Amber
Code: BNL1430070
Φ100x180mm
2W 200lm 2200K



E27 LED Avra Common Clear
Code: BNL1435070
Φ55x150mm
4W 500lm DIM 2700K



E27 LED Avra Common Smoked
Code: BNL1436070
Φ55x155mm
4W 300lm DIM 2700K



E27 LED Avra Air Clear
Code: BNL1433070
Φ90x185mm
4W 600lm DIM 2700K



E27 LED Avra Air Smoked
Code: BNL1434070
Φ90x185mm
4W 500lm DIM 2700K



E27 LED Avra Diamond Clear
Code: BNL1423070
Φ100x145mm
2W 150lm 2200K

Vari altri modelli e taglie disponibili.
NB: Flussi e potenze possono variare in caso di aggiornamenti tecnici.

Many others bulbs on request
Flux and power can be change in the next time

ACCESSORIES AND SUSPENSIONS

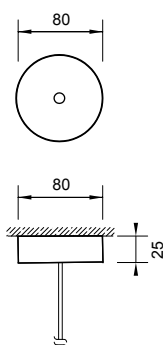

R80

Rosone tondo, diametro 80 mm, sospensione singola. Colore bianco, nero o su richiesta.
Ceiling rose, diameter 80 mm, single suspension.
White, black or on request.

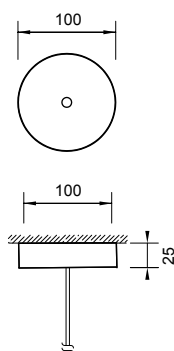

R100

Rosone tondo, diametro 100 mm, sospensione singola. Colore bianco, nero o su richiesta.
Ceiling rose, diameter 100 mm, single suspension.
White, black or on request.

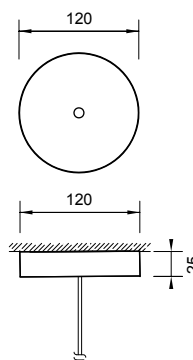

R120

Rosone tondo, diametro 120 mm. Disponibile nella versione con uno, due, tre o cinque cavi di sospensione. Colore bianco, nero o su richiesta.
Ceiling rose, diameter 120 mm. One, two, three or five pendant luminaires. White, black or on request.

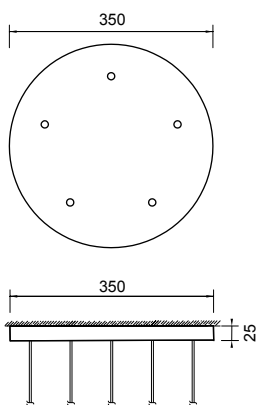

R350

Rosone tondo, diametro 350 mm. Disponibile nella versione con tre, cinque o sei cavi di sospensione. Colore bianco, ottone o rame.
Ceiling rose, diameter 350 mm. Three, five or six pendant luminaires. White, brass or copper.

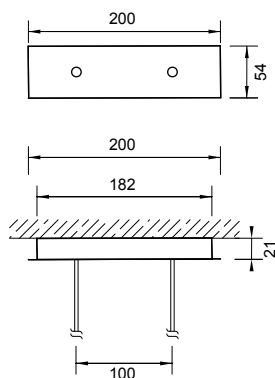

S200

Rosone rettangolare, dimensioni 200x54 mm. Colore bianco.
Rectangular rose, dimensions 200 x 54 mm. White colour.

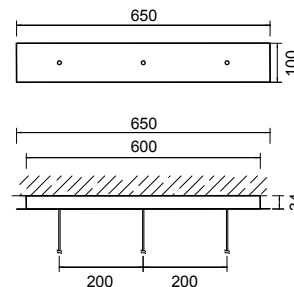

S650

Rosone rettangolare, dimensioni 650x100 mm. Colore bianco.
Rectangular rose, dimensions 650x100 mm. White colour.





14
ALLEGRA
Pendant



16
DIAMANTE
Pendant



18
LUCENTE
Pendant



20
BOLLA
Pendant



22
DIN-DON
Pendant



24
STELLA DORATA
Pendant



26
STELLA VETRO
Pendant



28
STELLA METAL
Pendant



30
DIVETRO 9 WOOD
Wall / Ceiling



32
DIVETRO 18 WOOD
Wall / Ceiling



33
DIVETRO 33 WOOD
Wall / Ceiling



34
DIVETRO 9
Wall / Ceiling



35
DIVETRO 9 - 18 - 33
Wall / Ceiling



36
COLORVETRO 9 - 18
Wall / Ceiling



37
COLORVETRO 33
Wall / Ceiling



44
TWIST
Pendant



46
MATERICA
Pendant



48
LELLO
Pendant



50
CROCCO
Pendant



51
CROCCO
Pendant



52
NILLO
Pendant



54
NILLO
Pendant



56
STRAPPO
Pendant



56
STRAPPO
Pendant



58
VASAI0
Pendant



59
VASAI0
Pendant



60
ELETTRA
Pendant

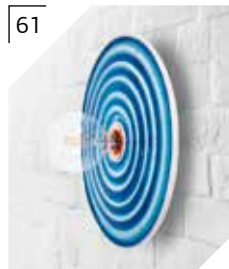

61
ELETTRA
wall / Ceiling



62
ARTU'
Pendant



64
SANMARTINO
Pendant



66
NOVE
Pendant



68
NOVETTINO
Pendant



70
SBARAZZINA
Pendant



72
SBARAZZINA
Table



74
NOVELLA
Table



75
NOVELLA
Pendant



76
AMELIE
Table



77
AMELIE
Pendant



78
COCÒ
Wall



80
COCÒ
Pendant



82
SERVO MUTO
Floor



84
GOCCE DI RUGIADA
Floor



LUNA PIENA
Pendant

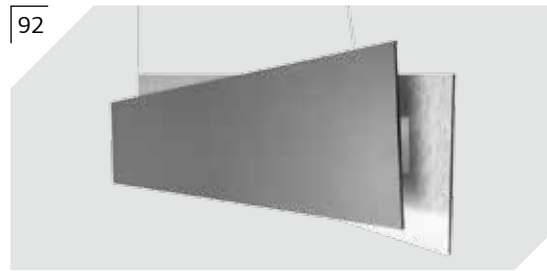

ZOPPA
Pendant



TUTTONDO
Pendant



LEGO
Ceiling



LEGO
Pendant



RULLO
Ceiling



RULLO
Pendant



MINIMAL A
MINIMAL A with glass
Pendant



MINIMAL B
MINIMAL B with glass
Pendant



MINIMAL C
MINIMAL C with glass
Pendant



ARMONIA
Wall



ARMONIA TWIN
Wall



ARMONIA
Pendant

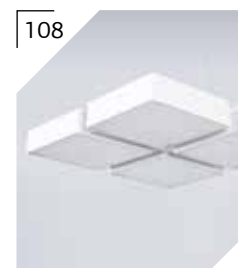

ARMONIA
Pendant



ARMONIA FLORA
Pendant



PURA
Table



SINUOSA
Table



SOTTILE
Floor



BORGHESE
Wall



BORGHESE
Wall



ELLISSE
Ceiling



ELLISSE
Pendant



SFERA
Ceiling



SFERA
Pendant



RIALTO
Wall



MASKERA
Wall



MASKERA
Wall



BULBS
LED 230Vac CRI>80



**ACCESSORIES
AND SUSPENSIONS**

Ringraziamenti / Special thanks

Mentore: Giuseppe Facchinello

Photo: Vania Broccoli

Concept: Nazario Frattin

ENGI SRL aderisce alla RIR Venetian Smart Lighting. ENGI SRL partecipa ai progetti di ricerca e sviluppo della regione Veneto DGR 1139

We are part of the group of Rete di Imprese Luce in Veneto, a network of Companies in the lighting field. Engi srl take part to Veneto Region's reserch and development projects:

- a) Venetian Smart Destination
- b) RIR ICT for smart and sustainable living
- c) RIR research and development on materials and machineries

Tutti i dati e le descrizioni in questo catalogo si intendono forniti solo a titolo informativo e non sono impegnativi per l'azienda produttrice, la quale si riserva il diritto di apportare variazioni e modifiche che si rendessero necessarie per ottenere ulteriori miglioramenti qualitativi dei prodotti. Si avvisa che i prodotti sono fatti a mano e per questa unicità possono presentare differenze nel colore o nella forma rispetto agli originali.

Vietata la riproduzione anche parziale di testi ed immagini.

All data and descriptions in this catalogue are provided only for information and not binding for the Company, and reserve the right to make necessary changes to improve the quality of its products. Products are handmade and for this reason unique, so they can be slightly different for the original one in this printed catalogue.

It is forbidden to copy texts and/or images.

ENGI Catalogo generale IT / EN Edizione 01—2019





ENGI srl
via Cassola 60
36027 Rosà (VI)
Italy

www.engi.it
info@engi.it

tel. +39 0424 582 534
fax +39 0424 587 185

